



Rapid Infinity

Catalogue 2017

Office Furniture Plus

77 Tapleys Hills Road,
Hendon SA 5014

Ph. 08 8211 9229

www.officefurnitureplus.com.au

WORKSTATIONS - FURNITURE - SEATING - STORAGE - ACCESSORIES

sales@officefurnitureplus.com.au



RAPID INFINITY FRAME



Select the Loop End Leg for a Distinctive, Premium Finish.

Profile 60 x 30mm End Leg Creates Simple, Clean Lines.

Pinable Black Screen provides Privacy whilst also Reducing Noise.

Double Telescopic Rail for Rigid Support.

Recessed Intermediate Leg for Maximum Leg Space.

Choose from the Profile or Loop Leg.

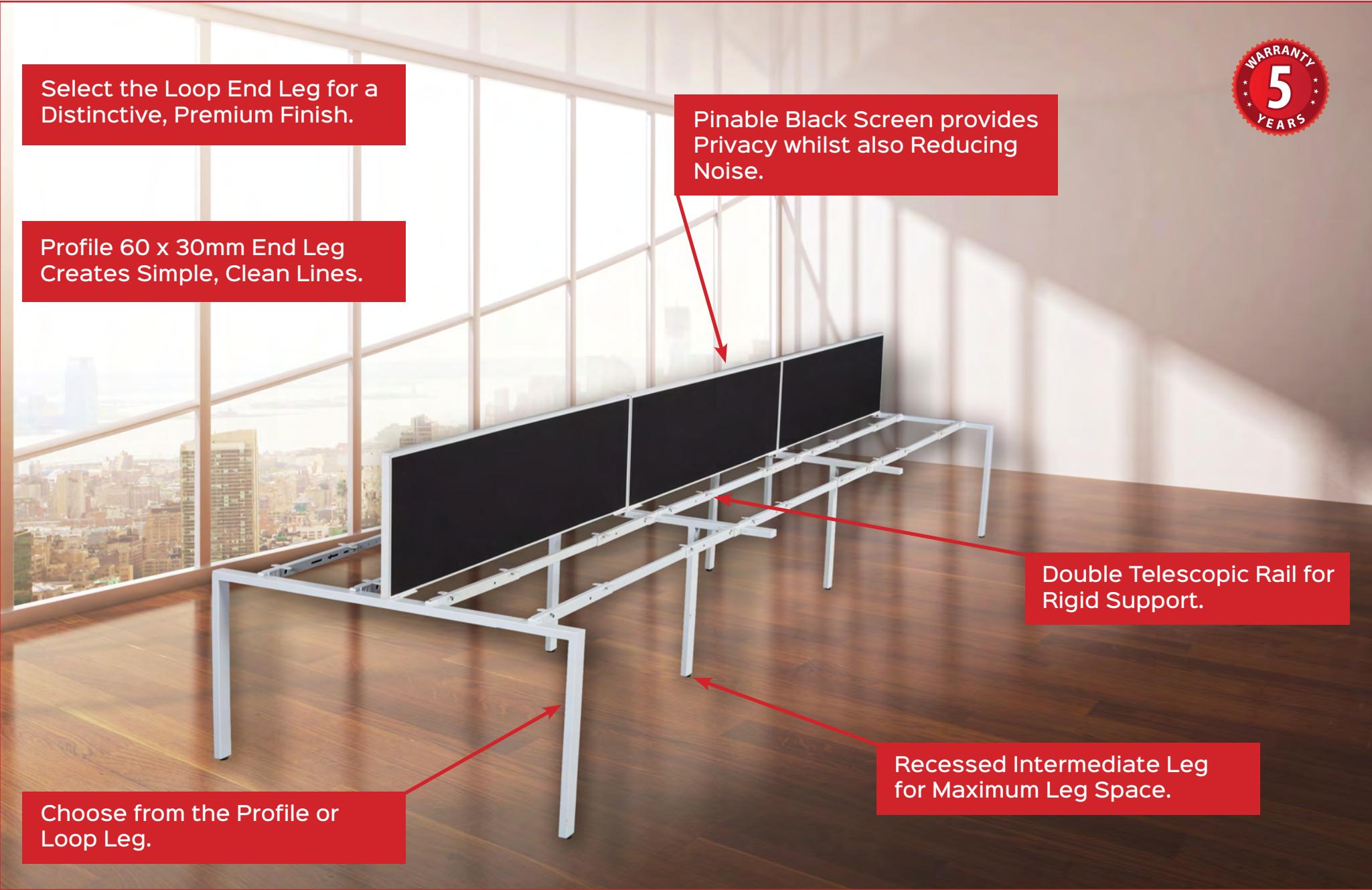

RAPID INFINITY CONFIGURATIONS

LOOP LEG



PROFILE LEG



SINGLE SIDED, NO SCREENS

From a single desk to long runs, ideal to use along walls.



SINGLE SIDED WITH SCREENS

500mm high screens add privacy and noise reduction.

Colour Choices

White

Beech

DOUBLE SIDED WITH SCREENS

Maximise use of space and minimise cost.

Workstation Sizes

1200 x 700
1500 x 700
1800 x 700



RAPID INFINITY COMPONENTS

WORKSTATION TOPS

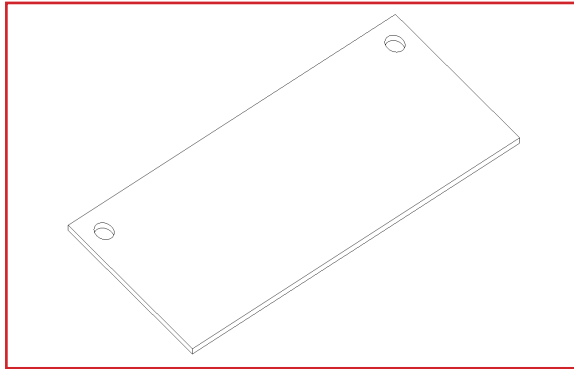

1200 x 700

1500 x 700

1800 x 700

Available in White or Beech

TELESCOPIC RAIL

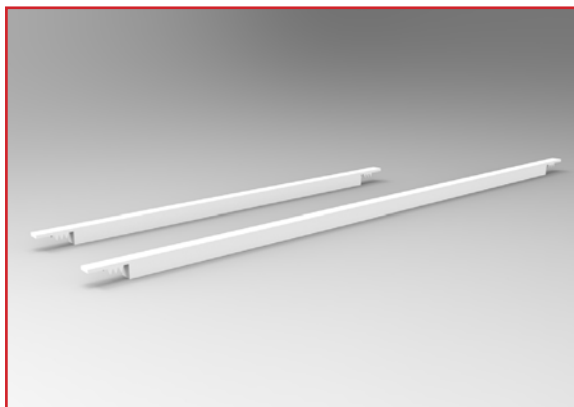

ITR 1012W for 1200W Tops

ITR 1518W for 1500 and 1800W Tops

INTERMEDIATE LEG - SINGLE

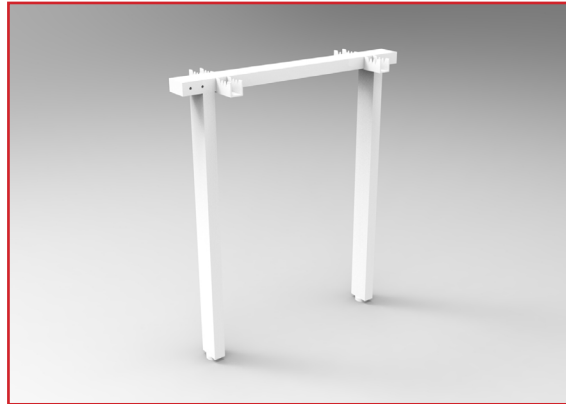

ISL W Intermediate Single Leg

INTERMEDIATE LEG - DOUBLE

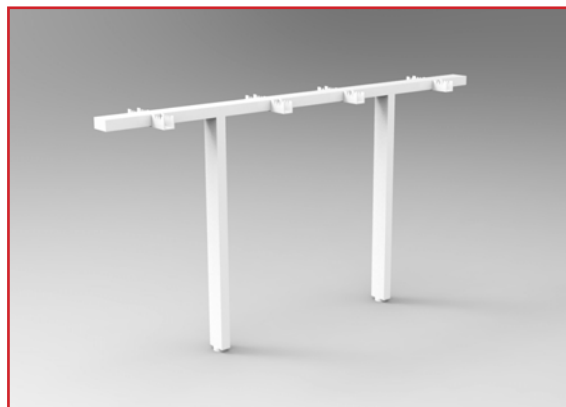

IDL W Intermediate Double Leg

OPTIONAL MODESTY PANEL

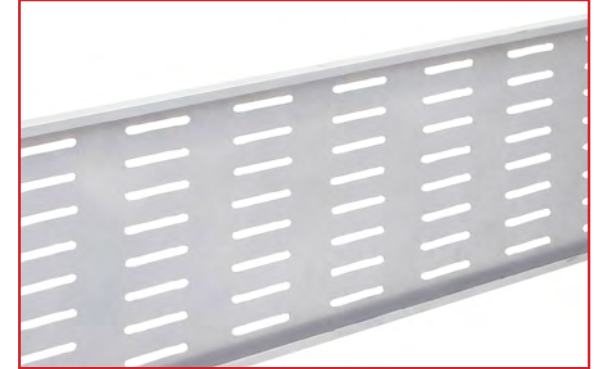

SPM127 W - 1200W

SPM157 W - 1500W

SPM187 W - 1800W

PINABLE SCREEN



IS 1200B 1200 x 500H

IS 1500B 1500 x 500H

IS 1800B 1800 x 500H

RAPID INFINITY COMPONENTS

PROFILE LEG - SINGLE



PSL W Single Profile Leg
60 x 30mm

LOOP LEG - SINGLE



LSL W Single Profile Leg
Angular Look

PROFILE LEG - DOUBLE

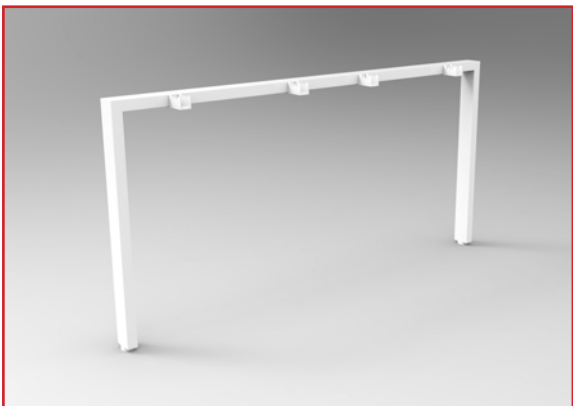

PDL W Double Profile Leg
60 x 30mm

LOOP LEG - DOUBLE

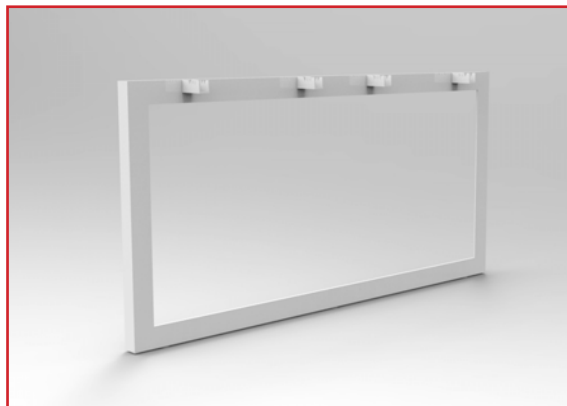

LDL W Double Profile Leg
Angular Look

FIXING PLATE

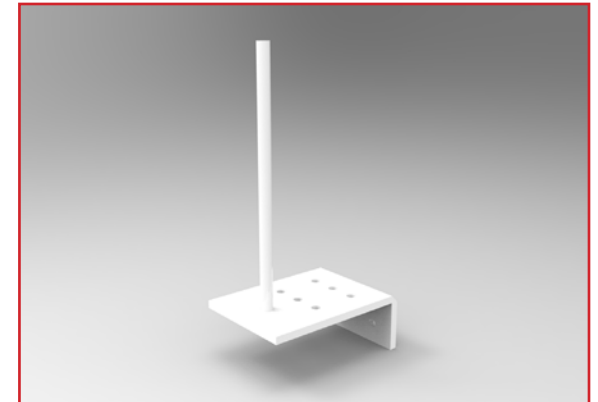

IS FD W - Screw Fix Plate for
Double Sided Screens
IS FS W - Screw Fix Plate for
Single Sided Screens

**ASK ABOUT THE FULL
RAPIDLINE FURNITURE RANGE**